

# MODULAR ALUMINUM MOBILE STRUCTURES





<b>01</b>	Company Profile	pag. 5
<b>02</b>	Special Applications for Aerospace	pag. 9
<b>03</b>	Special Applications for Aircraft	pag. 17
<b>04</b>	Special Applications for Military	pag. 25
<b>05</b>	Special Applications for Railway Vehicles	pag. 41
<b>06</b>	Special Applications for Industrial Equipment	pag. 45





# Company Profile

01

[WWW.FRIGERIOSPA.COM](http://WWW.FRIGERIOSPA.COM)

*Quality and Safety are our standards*

*Our mission is to achieve the totally customer satisfaction*

## Who we are

Frigerio Carpenterie Spa is a leading manufacturer of scaffolds, domestic and industrial aluminium ladders, fibreglass ladders, modular platforms, ramps and access stairs.

Starting from the raw material, we follow all the productive process by assuring to our customers the high quality and safety.

An important aspect of our management structure is our ability to respond quickly to customer demands.

The customer care has an important role; we strongly believe that keeping up to date with the customer requirements and exploring the different markets, it can improve the development, the technology of the products and the service.

For this our technical and project department is essentials. Thanks to our expert engineers we can study special structures and applications for every customer needs.

We are operating not only in the building and the industrial fields but we project and supply articles also for the government authorities, aerospace and military companies.

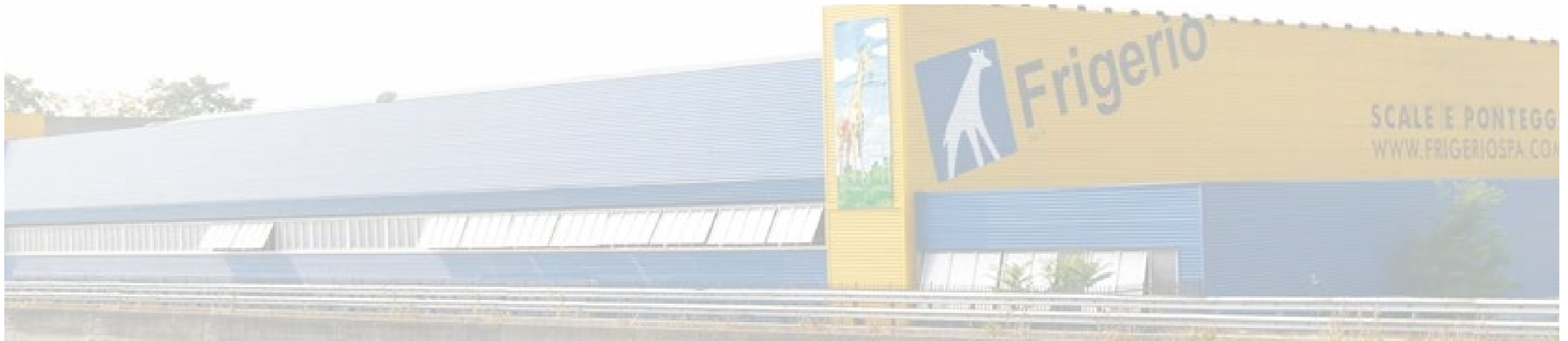

# Our History

In 1954 Frigerio Carpenterie was established by the family Frigerio and was specialized in manufacturing steel structures such as industrial hangars, fire escapes, movables scaffolds and telescopic ladders .

In 1968 we started the production of movable scaffolds on galvanized steel wheels.

In 1976 we started the production of professional aluminium ladders and telescopic ladders.

**In 1990 we are the first company in Italy to manufacture the aluminium scaffolds.**

In 1999 we started the production of the 7000 line, professional industrial ladders.

In 2014 we started the production of the Aluway line, collective protection system.

## Frigerio S.p.A in the World

We are present in the Italian market with more than 2500 distributors and we export our products all around the world.

**Export Market**  
Center and North Europe  
Middle East  
Far East  
Central America

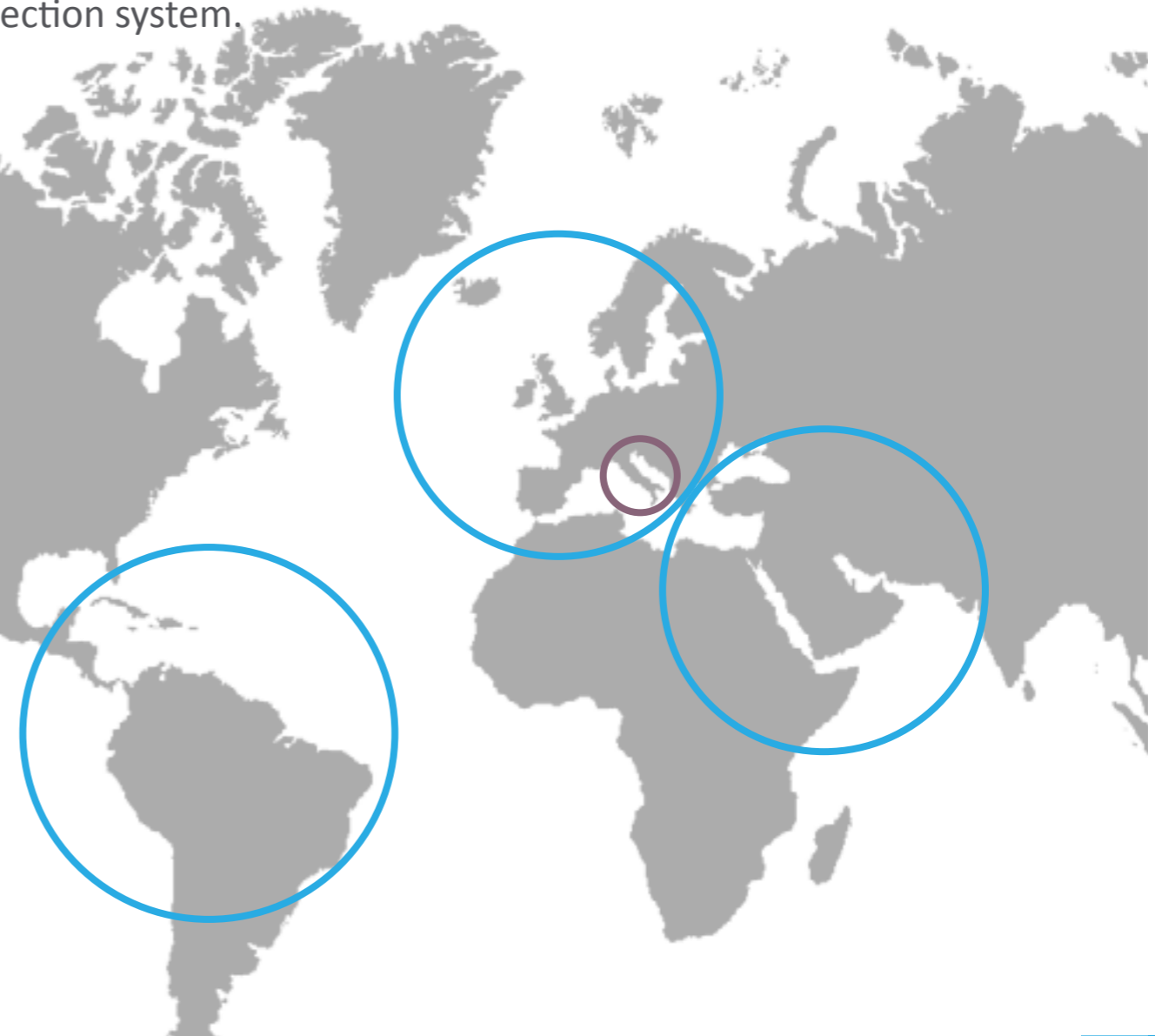

*Quality and Safety are our standards*

*Our mission is to achieve the totally customer satisfaction*

## Our Strength

Direct presence on the territory with our local sales network

Direct line customer service

Direct consulting and real-time configuration through our engineering department

Structural customized design according to your individual requirements

High dimensional accuracy manufacturing

Maximum work safety

Compliance with all relevant standards

Functional and cost-efficient technological solutions

Fast worldwide delivery

Product assurance till 300.000 euro

“Made in Italy” with 5 years warranty

## Our Standards

### QUALITY

Company’s quality system approved by TUV-Product Service;

Accurate quality control on incoming material;

Use of aluminium alloy certified at origin;

Pre-assembling tests are carried out in factory before the delivery;

Welding certified system

### SAFETY

Statement of conformity supplied with the structure together with mounting and mandatory instructions;

Constant update;

### Certifications and tests

Carried out by certification institutes recognize to Alupont scaffold type the belonging to class 3 (200kg/mq), the highest category provided for UNI EN 1004

### WARRANTY

5 Years Warranty;

Product insurance

### ASSISTANCE

Pre-sale and Post-sale assistance;

Training courses



# Alupont System Modular Aluminum Structure

ALUPONT System represents one of the most functional and cost-efficient technological solution used from FRIGERIO SpA for the construction of modular aluminium mobile maintenance tower and custom-made applications.

ALUPONT modular construction system increases worker's safety at high altitude and in heavy working conditions; it also meets the quickly and practically requirements during each assembling step.



## Flexibility in structure reconfiguration

Alupont modular construction system allows you to reuse components to assemble structures with different configurations from the initial ones or extend the existing configuration by adding additional components.



## Extreme versatility

Alupont range permits to work on stairs, unlevelled ground and on overhanging.



## Automatic hand hooks connection

provide a safety locking between brace and frame.



## Automatic locking connection

Locking connection system between the frames does not require non manual worker's.



## Frame thickness reinforced to 2 mm

High resistance aluminium tubular profile with increased thickness to grant an elevated breaking load, higher tensile strength and the most secure reliability in time.



## Integrated ladders

Each frame can be used as vertical ladder for access to the working platform.



## High resistance working surfaces

Working platform with a max charge of 200 Kg/mq.

Working surfaces in Finnish birch anti-slip, waterproof or aluminium almond sheet.

Safety device against wind or accidental lifting.

Trap door passage with automatic locking device.



## Adjustable extenders

Provided with articulated leg with rubber insole that ensures better stability on all type of terrain and perfect positioning even on uneven surfaces.



## Castors Ø 150 mm polyurethane

EN 1004 certified, Made in Italy.

Equipped with dual brake lever.



## Integrated telescopic legs

Telescopic legs integrated in the base frame allows to compensate differences in height up to 35 mm.





# Special Applications for Aerospace

02

Maintenance structure for interferometric gravitational wave detector VIRGO  
provided to European Gravitational Observatory (EGO)

- 01 Project development
- 02 Structure detail
- 03 Structure realization
- 04 Project realization





Maintenance aluminium working structure with dual working levels and access ladders designed for European Space Agency (ESA) full-size test version of the service module

- 01 Project development
- 02 Structure detail
- 03 Structure detail
- 04 Structure detail
- 05 Project realization

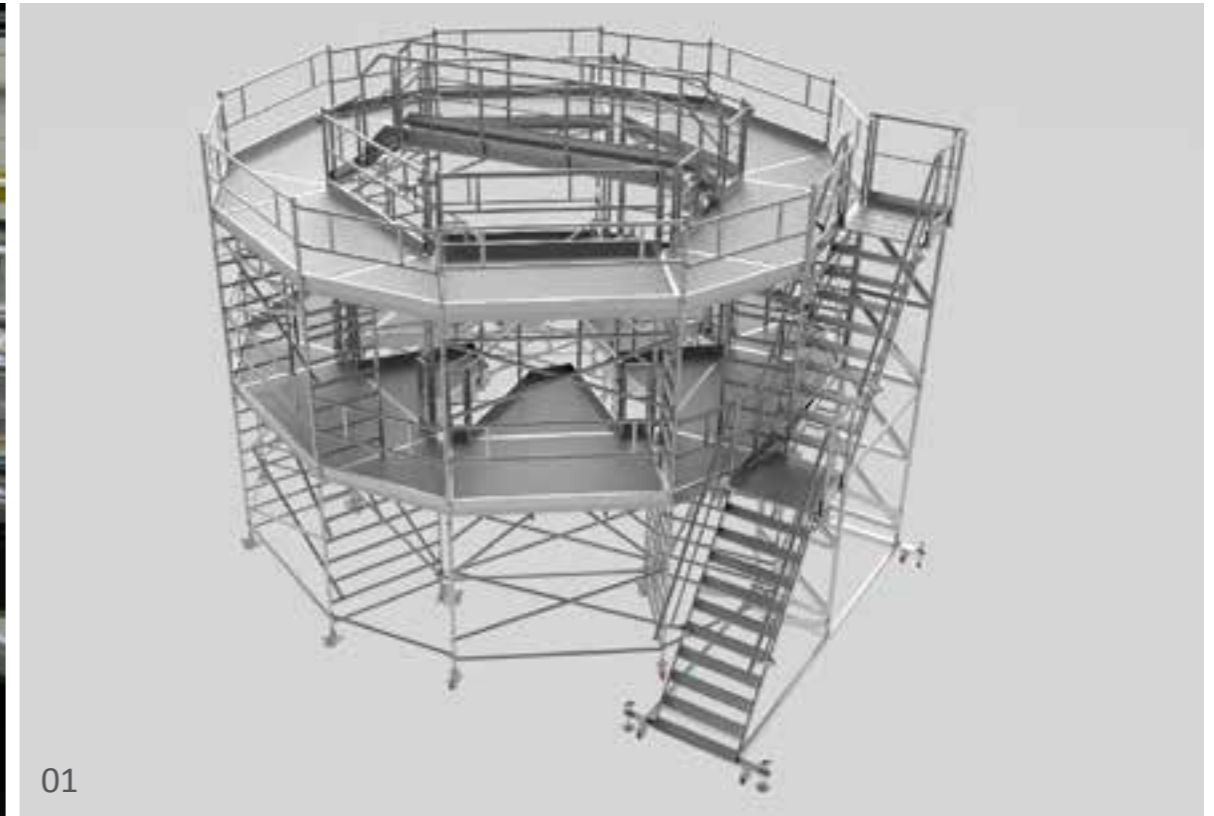



Maintenance structure with cantilever working platforms and access ladders  
designed for European Space Agency (ESA)

- 01 Project development
- 02 Structure realization
- 03 Structure realization
- 04 Structure detail
- 05 Project realization







**Modular maintenance structure with access ladders**  
 designed to test the opening of NASA satellite's solar pannels

- 01 Project developement
- 02 Structure detail
- 03 Structure detail
- 04 Structure detail
- 05 Project realization

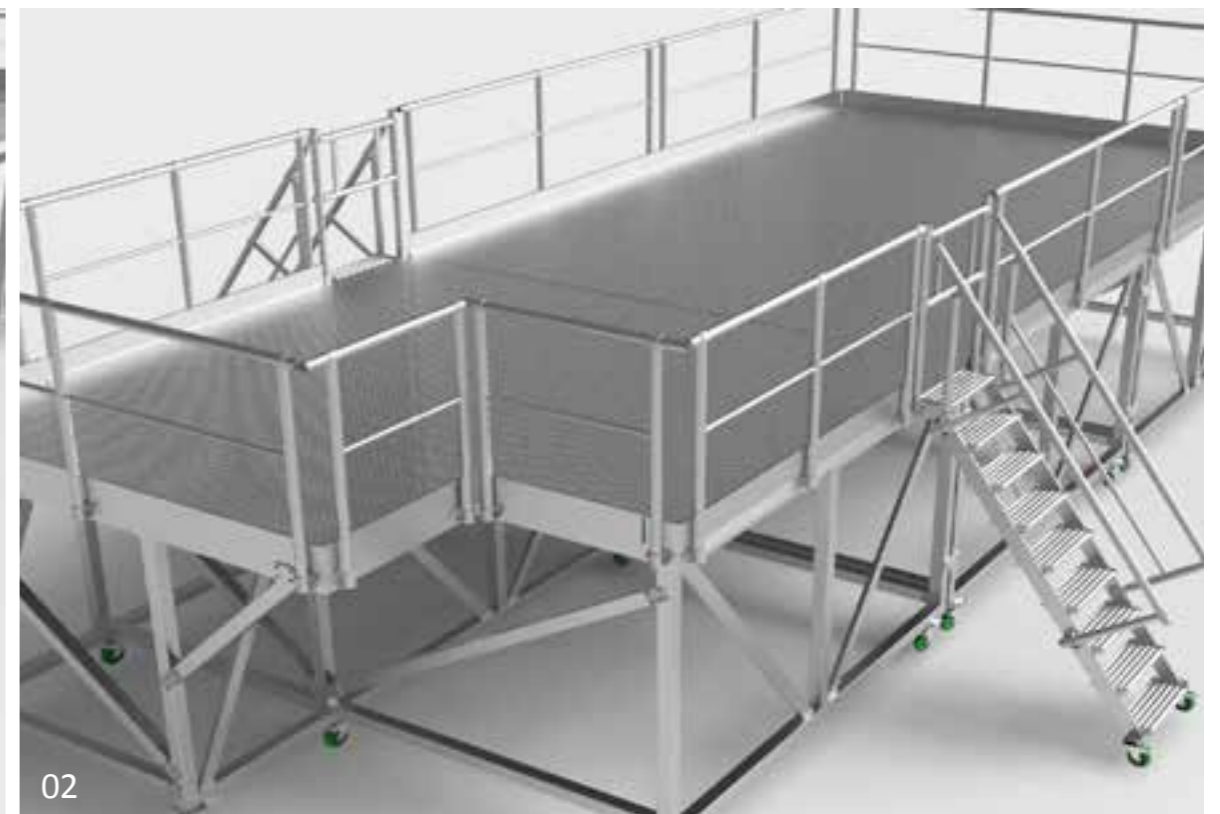
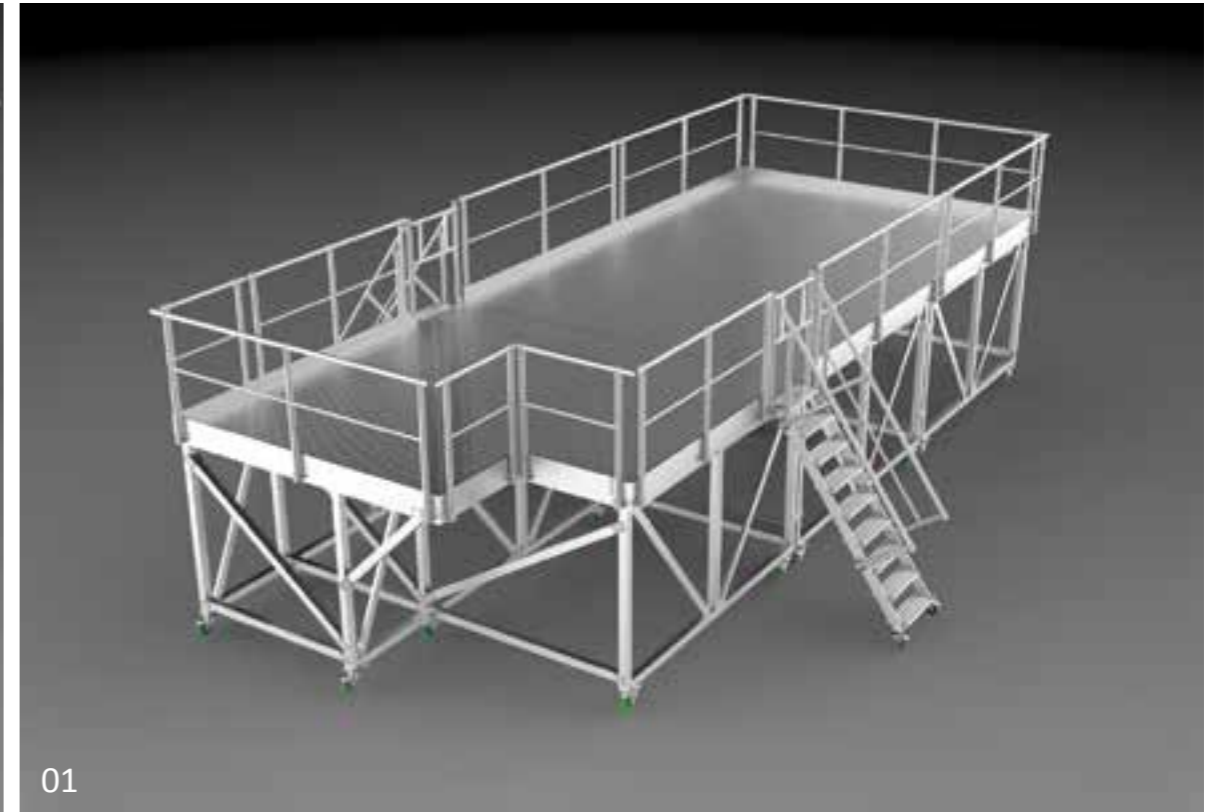
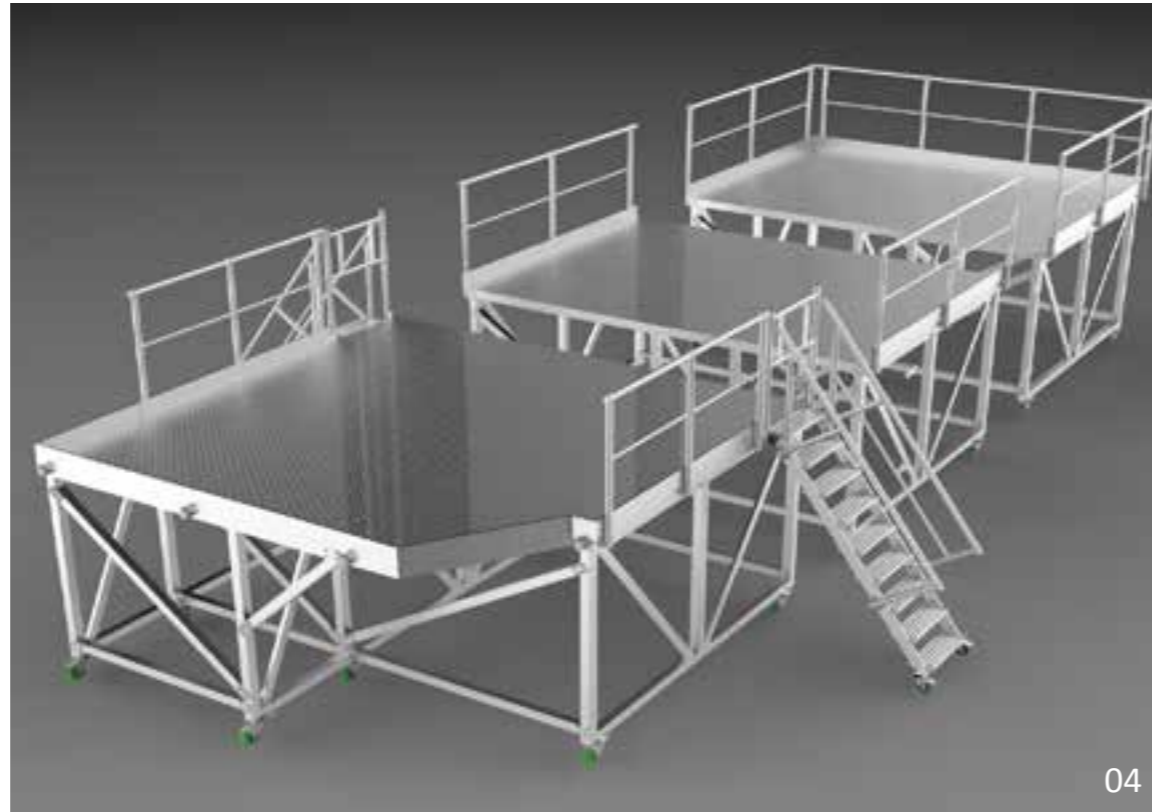



**Maintenance aluminium structure with special execution shaped platform**  
designed for European Space Agency (ESA) satellite's realization

- 01 Structure detail
- 02 Structure detail
- 03 Structure realization
- 04 Project realization
- 05 Project realization









# Special Applications for Aircraft

03

**Modular aluminum mobile structure with access ladders and cantilever platforms designed for Alenia Aermacchi C-257 Spartan aircraft maintenance**

- 01 Project development
- 02 Structure realization
- 03 Structure detail
- 04 Project realization







**Modular aluminum mobile structure with access ladders and cantilever platforms**  
designed for Alenia Aermacchi C-257 Spartan aircraft maintenance

- 01 Structure detail
- 02 Structure detail
- 03 Structure detail
- 04 Project realization





**Modular aluminum mobile structure with access ladders and cantilever platforms designed for Alenia Aermacchi C-257 Spartan aircraft maintenance**

- 01 Project realization
- 02 Project realization
- 03 Project realization
- 04 Project development





**Mobile aluminium maintenance structure with cantilever platform, steel stabilizer base and internal access ladders**  
designed to perform quality control inspections on BOEING 787-9 fuselage aircraft sections

- 01 Project development
- 02 Structure detail
- 03 Structure realization
- 04 Project realization





**Modular aluminium mobile working structure**  
designed for PM180 aircraft front rotors and tail maintenance

- 01 Structure realization
- 02 Structure realization
- 03 Structure realization
- 04 Structure realization
- 05 Project realization











# Special Applications for **Military**

04

Maintenance platform with variable working height and modular telescopic platform designed to adapt to the fuselage's shape of the Italian Army Aviation CH47-C helicopter

- 01 Project development
- 02 Structure detail
- 03 Structure realization
- 04 Project realization





**Mobile aluminum working platform with access ladder**  
designed for rear rotor maintenance of the Italian Army Aviation CH47-C helicopter

- 01 Project development
- 02 Structure detail
- 03 Structure realization
- 04 Project realization





**Mobile aluminum working platform with variable working height**  
designed for rear rotor maintenance of the Italian Army Aviation CH47-C helicopter

- 01 Project development
- 02 Structure detail
- 03 Structure realization
- 04 Project realization







**Maintenance platform with variable working height and modular telescopic platform designed to adapt to the fuselage's shape of the Italian Army Aviation CH47-C helicopter**

- 01 Project development
- 02 Structure detail
- 03 Structure detail
- 04 Structure realization
- 05 Project realization

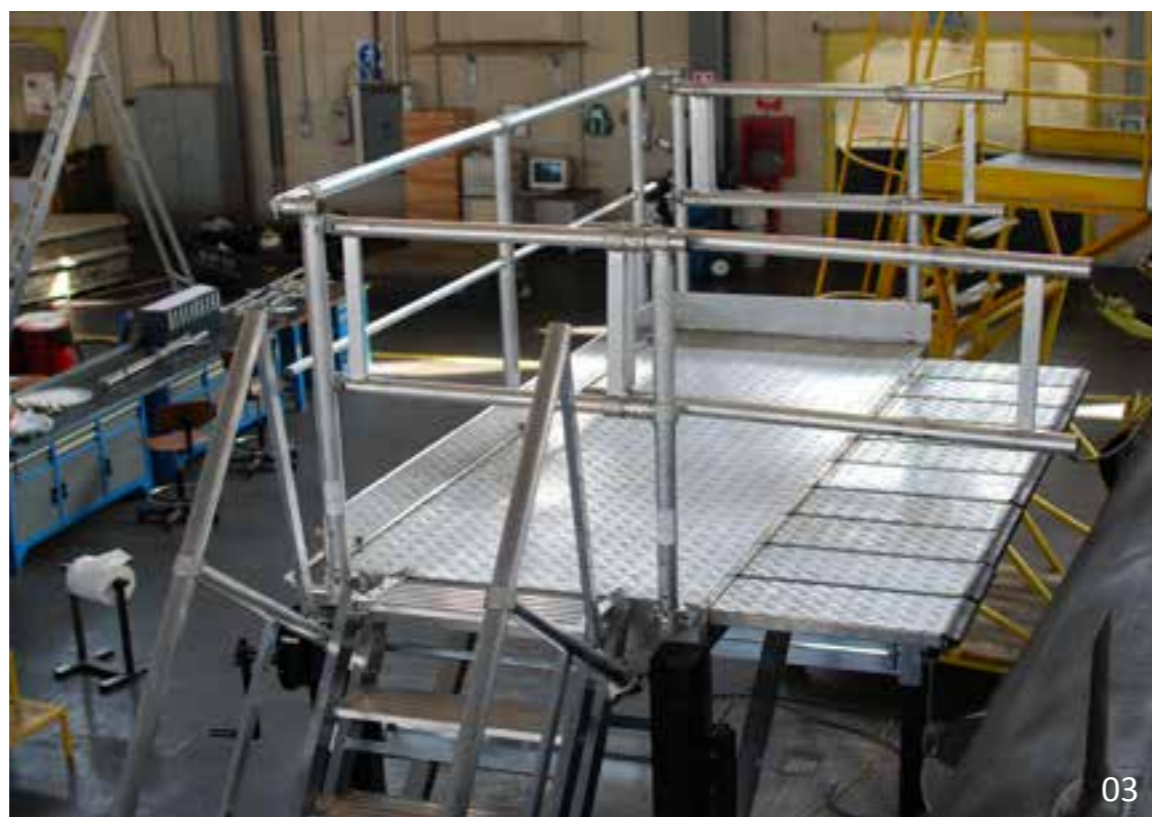
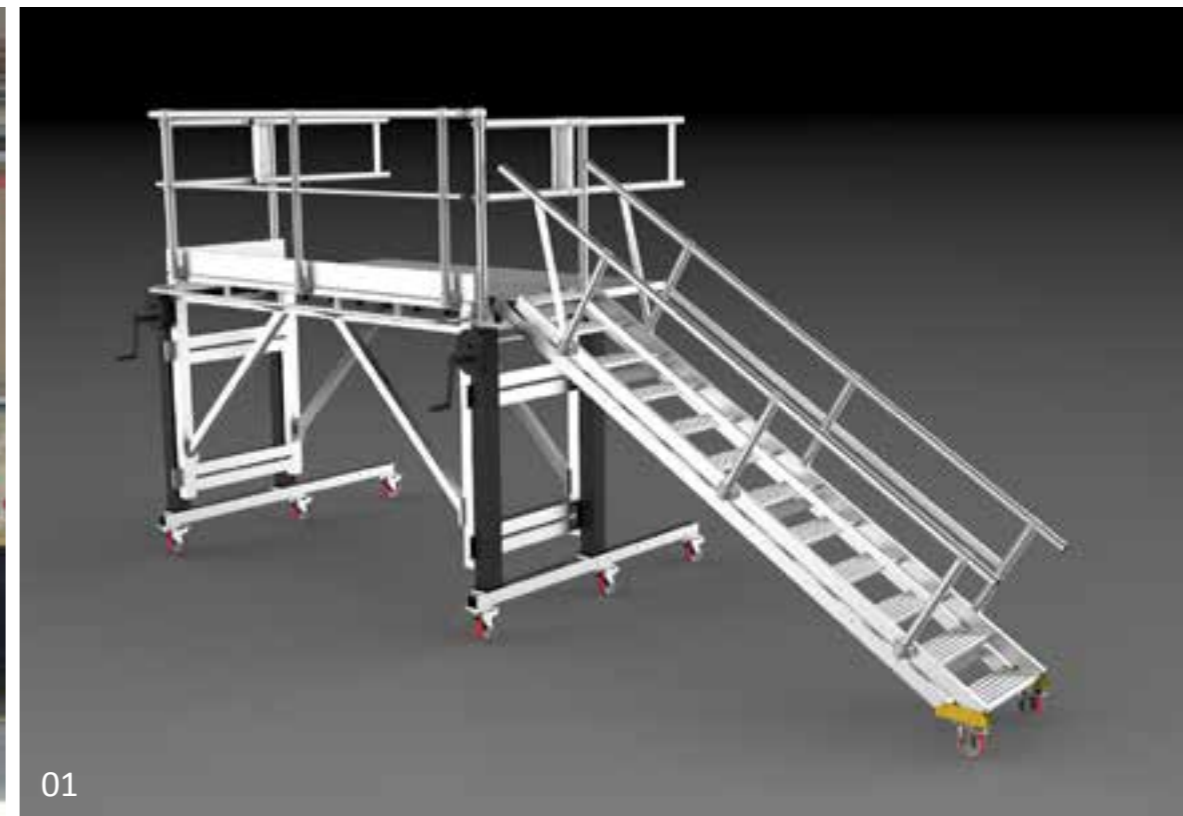



Maintenance platform with variable working height and modular telescopic platform designed for rear rotor maintenance of the Italian Army Aviation CH47-C helicopter

- 01 Structure detail
- 02 Structure detail
- 03 Structure realization
- 04 Project realization





Maintenance platform with variable working height and modular telescopic platform designed for front rotor maintenance of the Italian Army Aviation CH47-C helicopter

- 01 Structure detail
- 02 Structure detail
- 03 Structure realization
- 04 Project realization





**Modular aluminium working platform with access ladder**  
designed for Augusta Westland helicopters maintenance

- 01 Project development
- 02 Project realization
- 03 Project realization
- 04 Project realization



03



01



02





**Modular aluminium working platform with access ladder**  
designed for helicopters maintenance

- 01 Project development
- 02 Project development
- 03 Structure detail
- 04 Project realization
- 05 Project realization

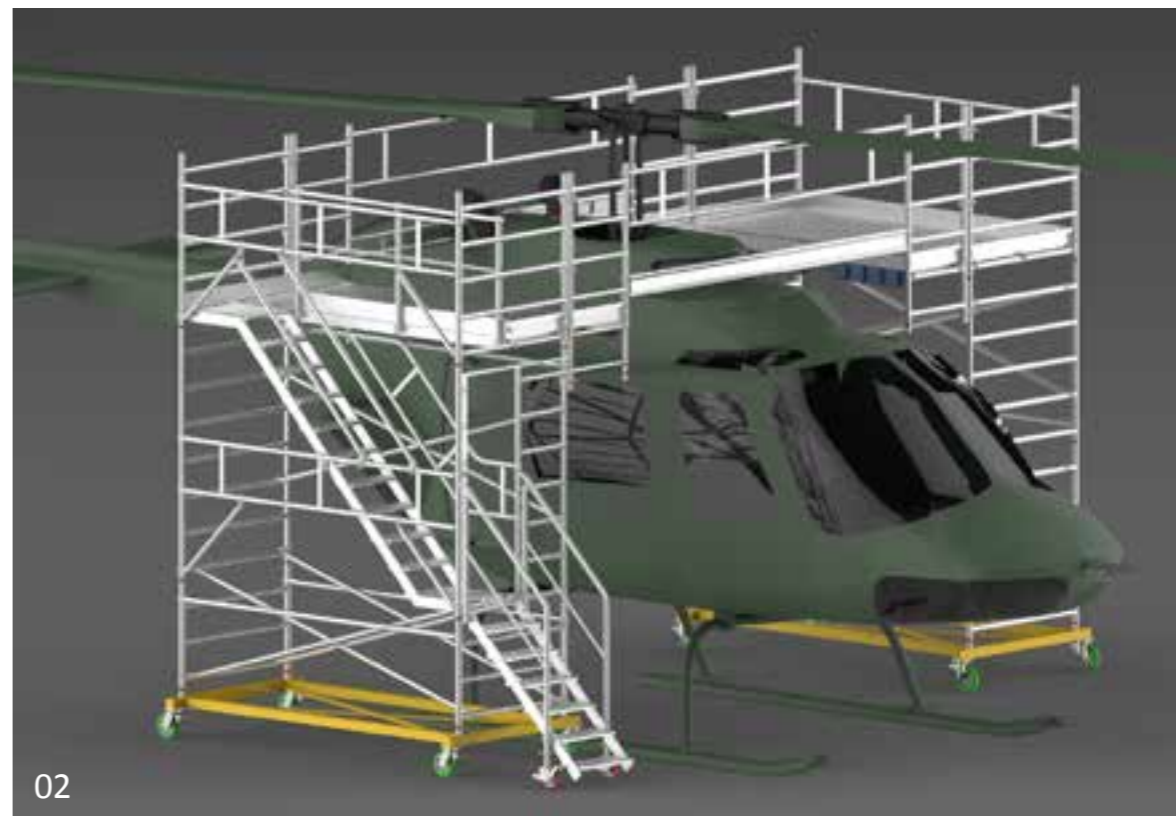
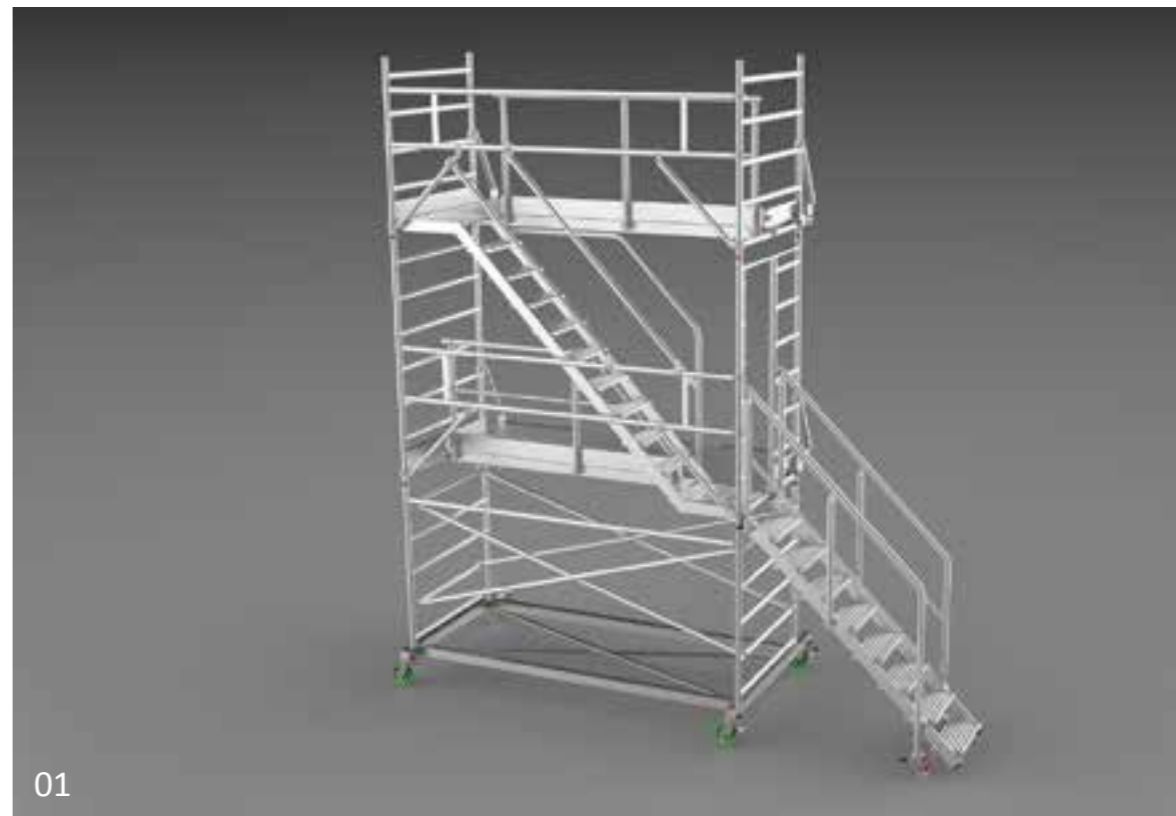







Special Applications for **Railway Vehicles**

05

Modular aluminium mobile structure with cantilever working platform and internal access ladders designed to provide collective safe access protection during train maintenance operations

- 01 Structure detail
- 02 Structure detail
- 03 Structure detail
- 04 Project realization



03



01



02



Modular aluminium mobile structure with cantilever working platform and internal access ladders designed to provide collective safe access protection during train maintenance operations

- 01 Structure detail
- 02 Structure detail
- 03 Structure detail
- 04 Structure detail

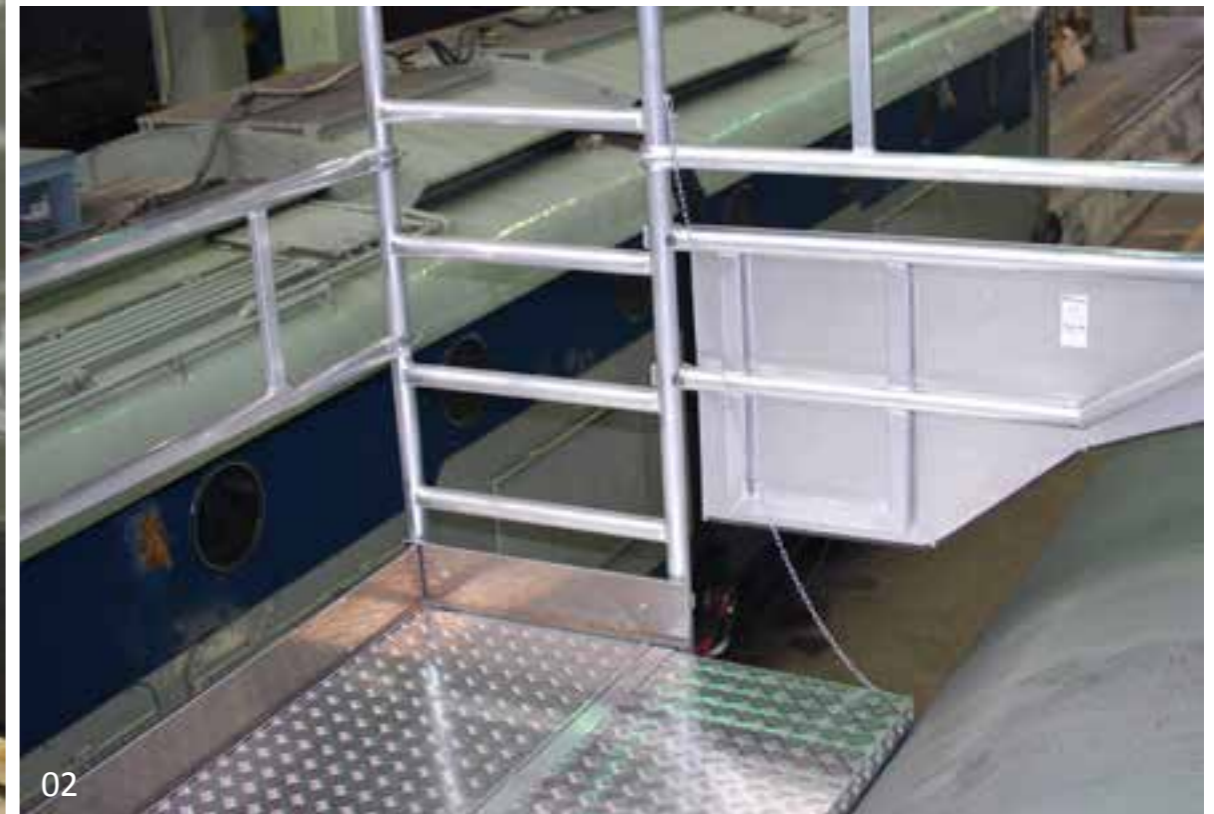





Modular aluminium mobile structure with cantilever working platform and internal access ladders designed to provide collective safe access protection during train maintenance operations

- 01 Project development
- 02 Project development
- 03 Project development
- 04 Project development

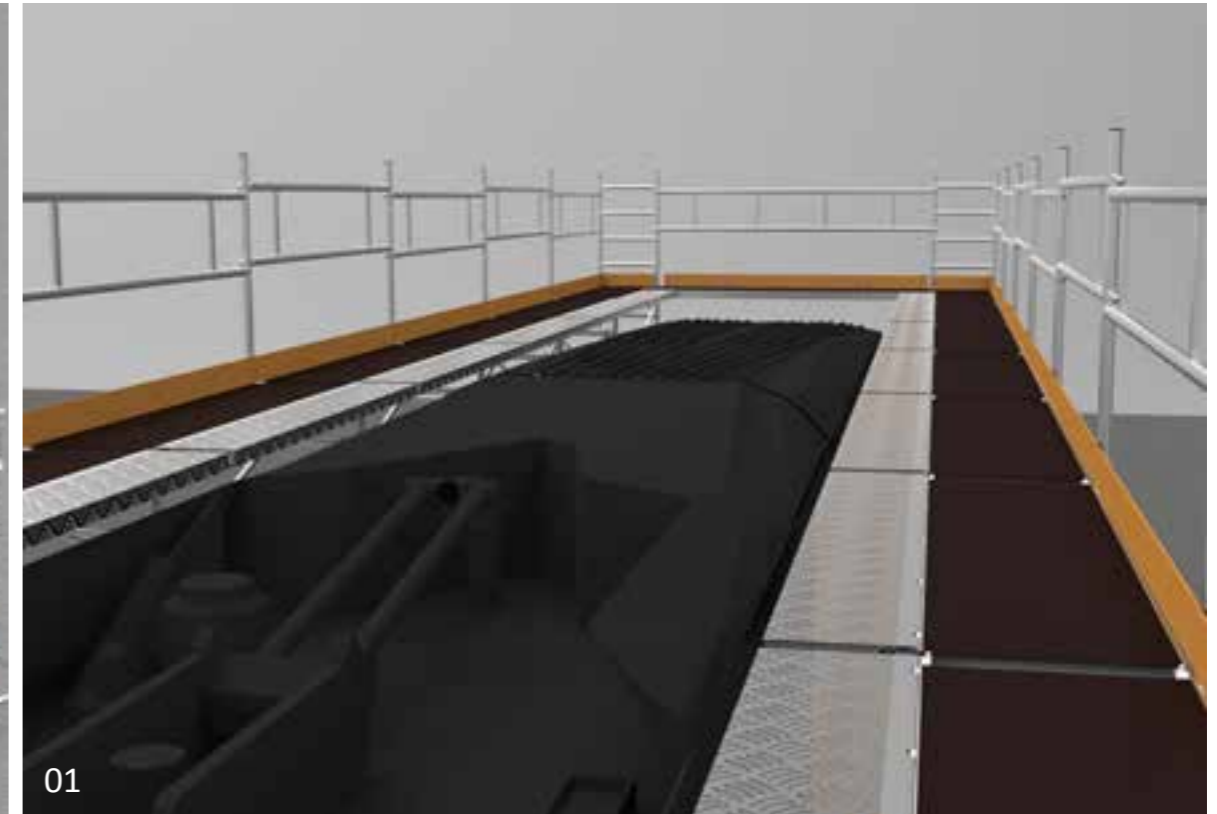

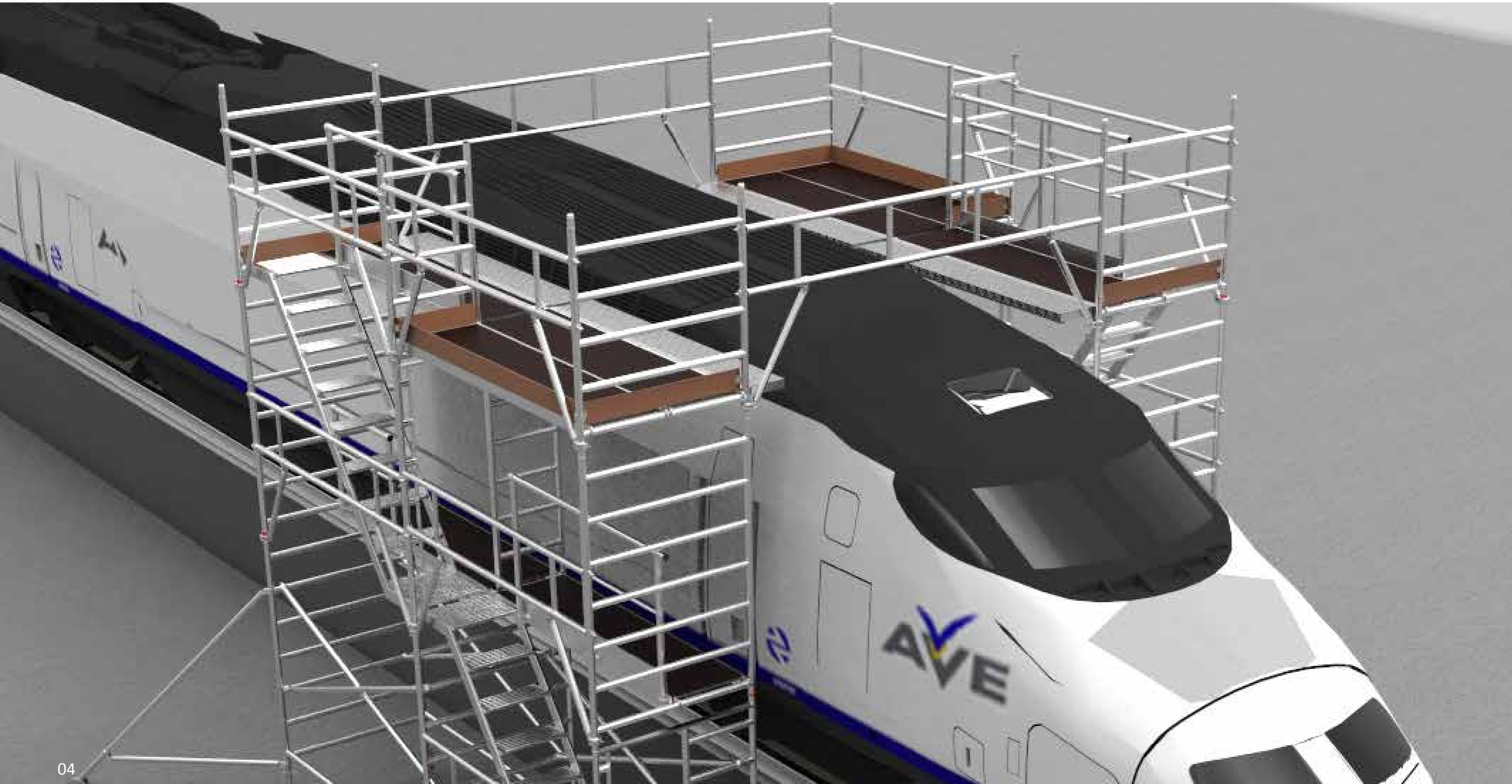

**Modular aluminium working platform with variable working hieght access ladders**  
designed to provide safe access and collective protection during train maintenance operations

- 01 Project developement
- 02 Structure detail
- 03 Structure detail
- 04 Structure detail
- 05 Project realization



04

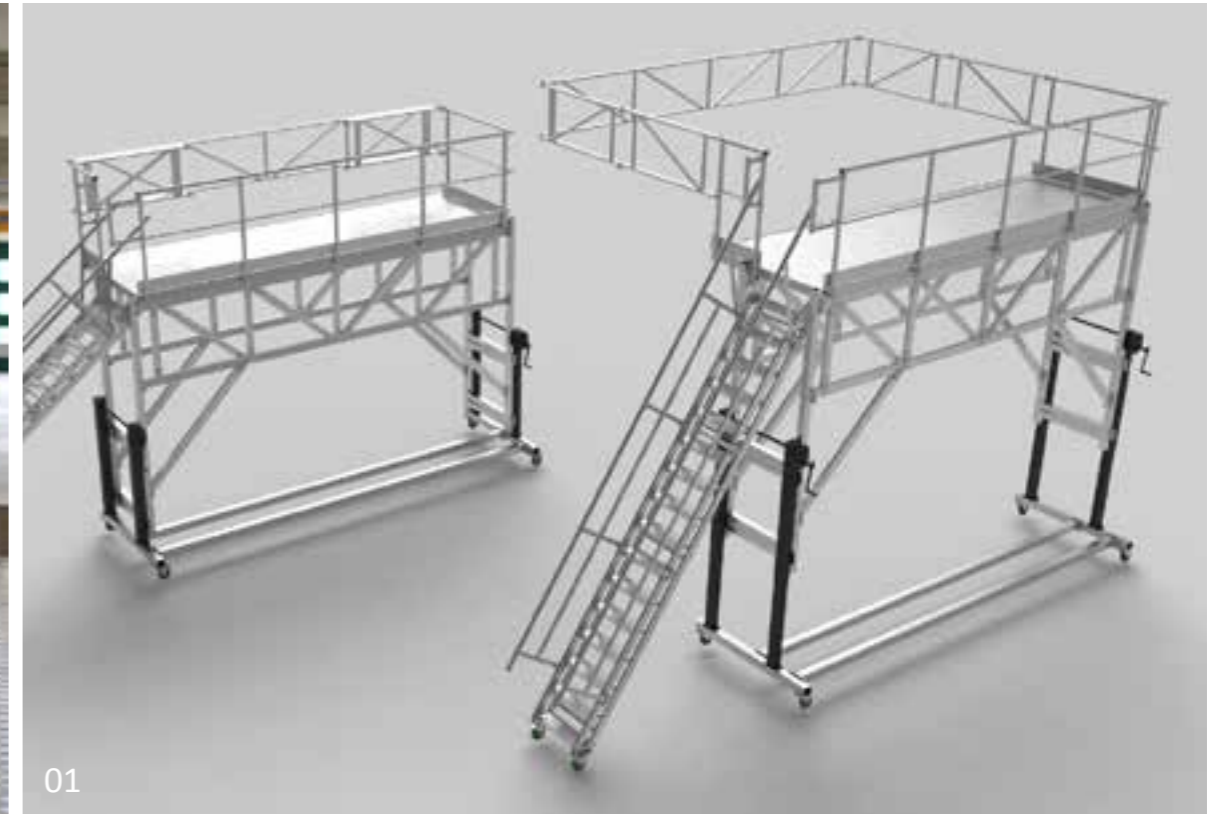

01



03



02



05

**Modular aluminium working platform with variable working hieght access ladders**  
designed to provide safe access and collective protection during train maintenance operations

- 01 Structure detail
- 02 Structure detail
- 03 Structure detail
- 04 Project realization



03



01



02



04







# Special Applications for Industrial Equipment

06

Aluminum Aluway Shed passages composed of gangway and ladder designed to provide collective safe routes on non-load bearing surfaces

- 01 Project development
- 02 Structure detail
- 03 Structure realization
- 04 Project realization

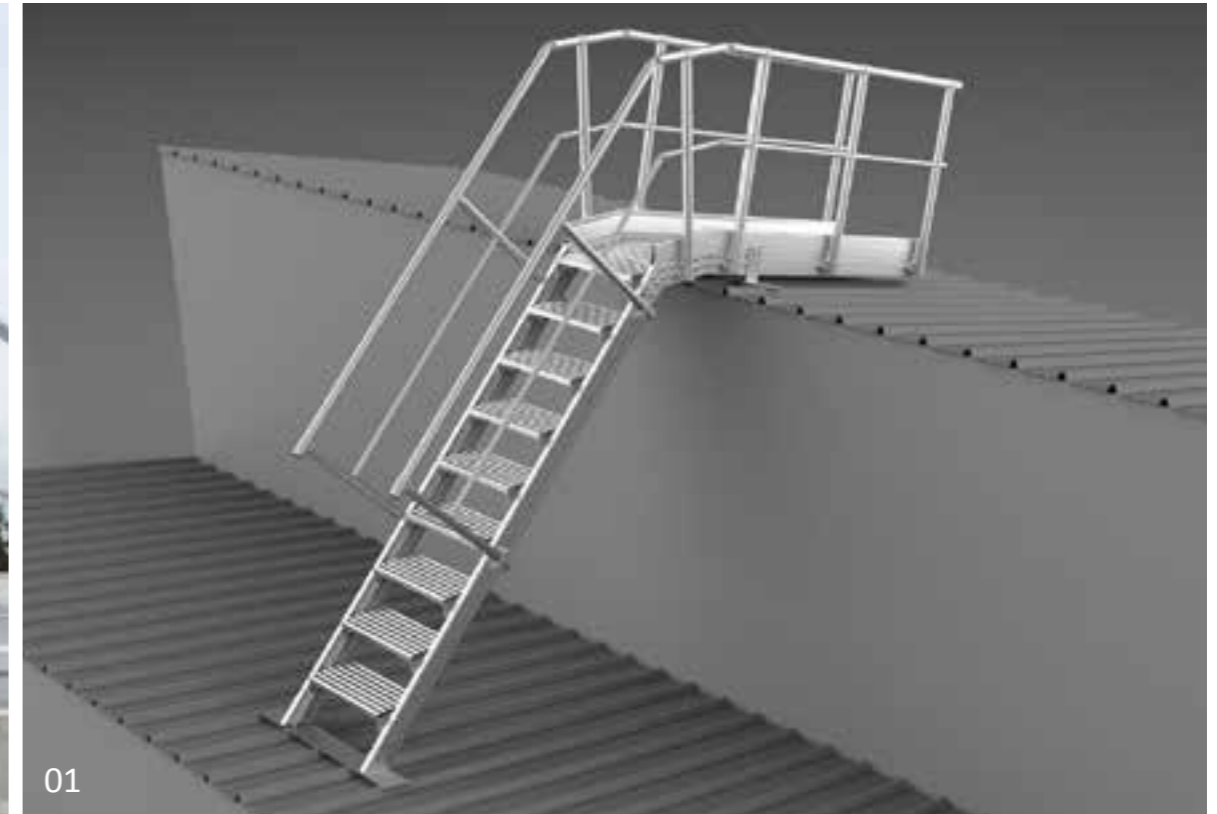



Aluminum Aluway overpass gangway composed of gangway and ladders designed to provide collective safe routes to overpass obstacles

- 01 Project development
- 02 Structure detail
- 03 Structure realization
- 04 Structure detail
- 05 Project realization



03



01



02



Aluminum Aluway Shed passages composed of gangway and ladders designed to provide collective safe routes on non-load bearing surfaces

- 01 Structure detail
- 02 Structure detail
- 03 Structure detail
- 04 Structure detail
- 05 Project realization





Aluminum Aluway Shed passages composed of gangway and ladders designed to provide collective safe routes on non-load bearing surfaces

- 01 Structure detail
- 02 Structure detail
- 03 Structure detail
- 04 Structure detail
- 05 Project realization

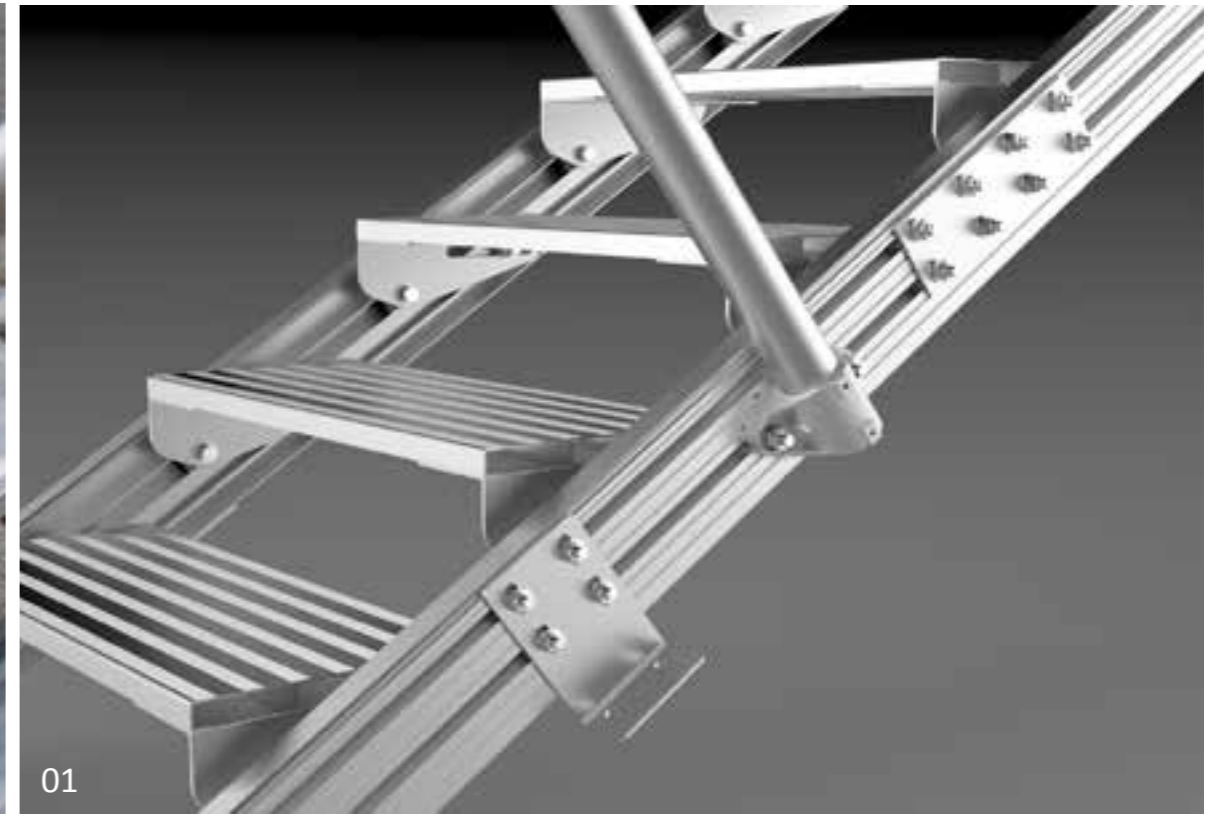





Modular aluminium working platform with access ladders  
designed for automotive industries production process

- 01 Structure realization
- 02 Structure detail
- 03 Structure realization
- 04 Structure realization
- 05 Project realization





Modular aluminium working platform with access ladder  
designed for automotive industries production process

- 01 Structure detail
- 02 Structure detail
- 03 Structure realization
- 04 Project realization





**Modular aluminium special execution working structure**  
designed for industrial production process

- 01 Project development
- 02 Project development
- 03 Project development
- 04 Project realization
- 05 Project realization



04



01



03



02



Modular aluminium mobile working platform with access ladders designed for special applications

- 01 Project development
- 02 Project development
- 03 Project development
- 04 Project development
- 05 Project development

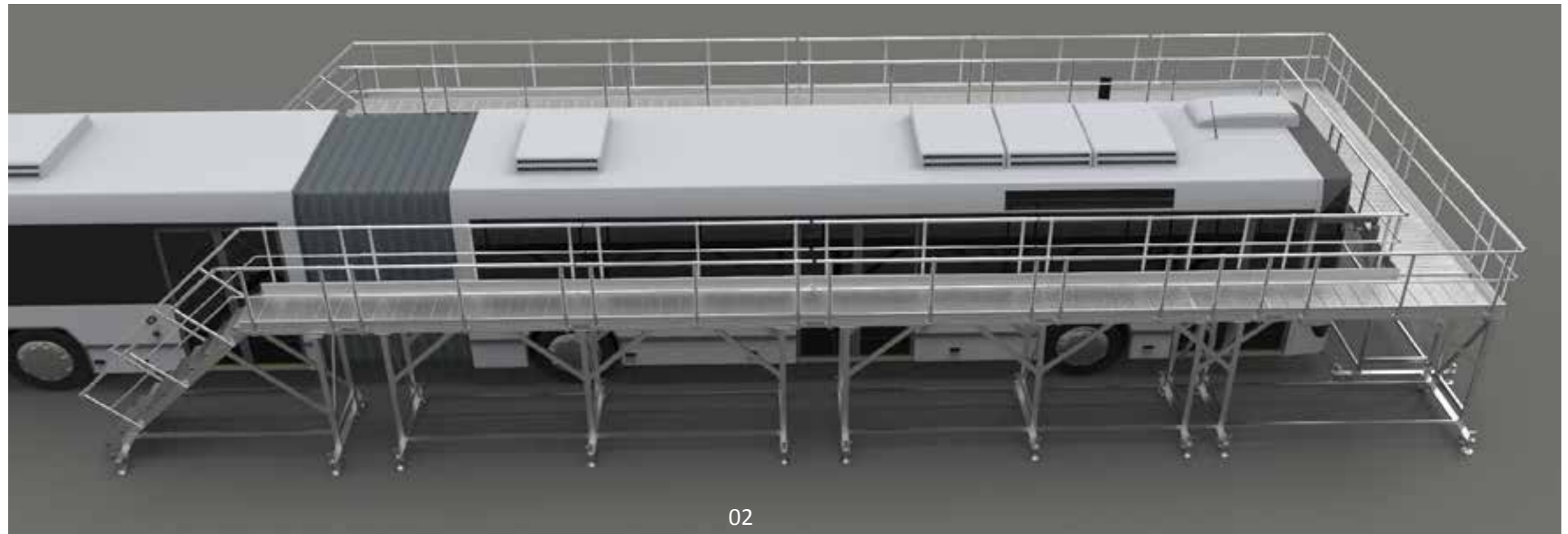
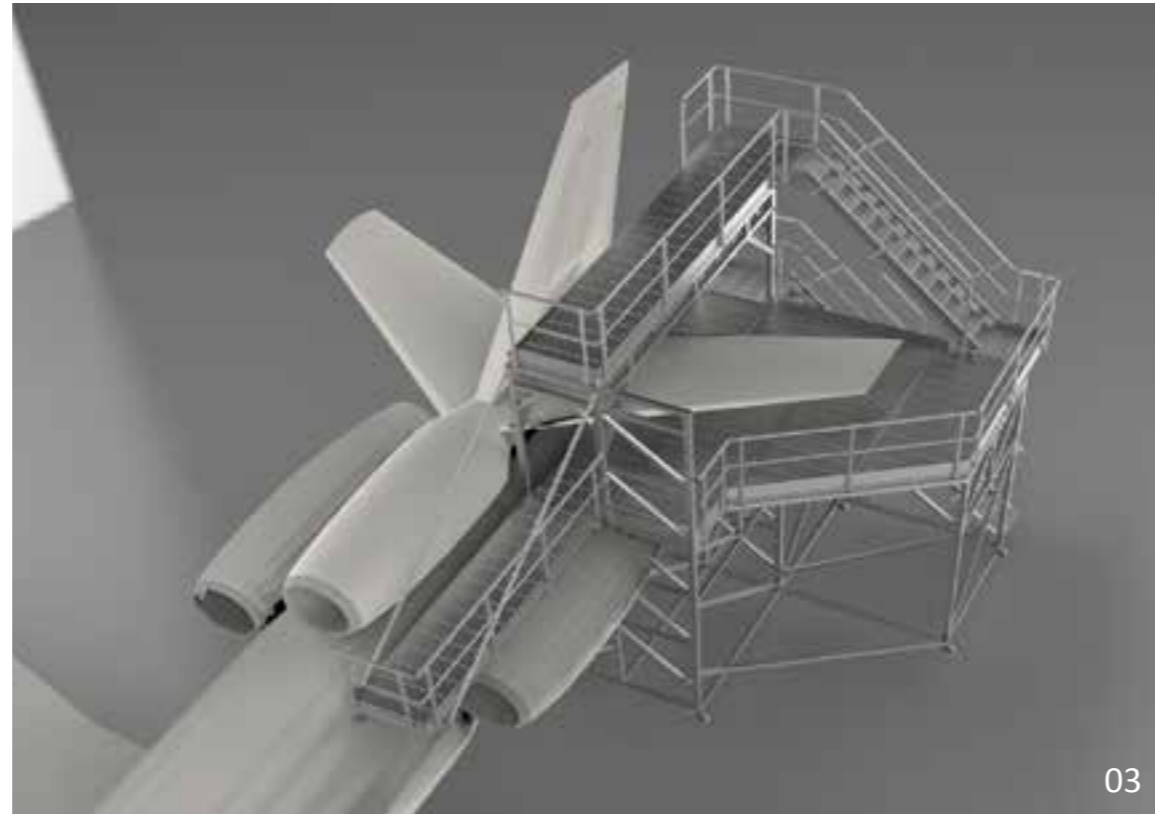





Aluminium access ladder with fibreglass moduled grating platform and stair treads designed for special applications

- 01 Project development
- 02 Project development
- 03 Structure detail
- 04 Project development
- 05 Project development

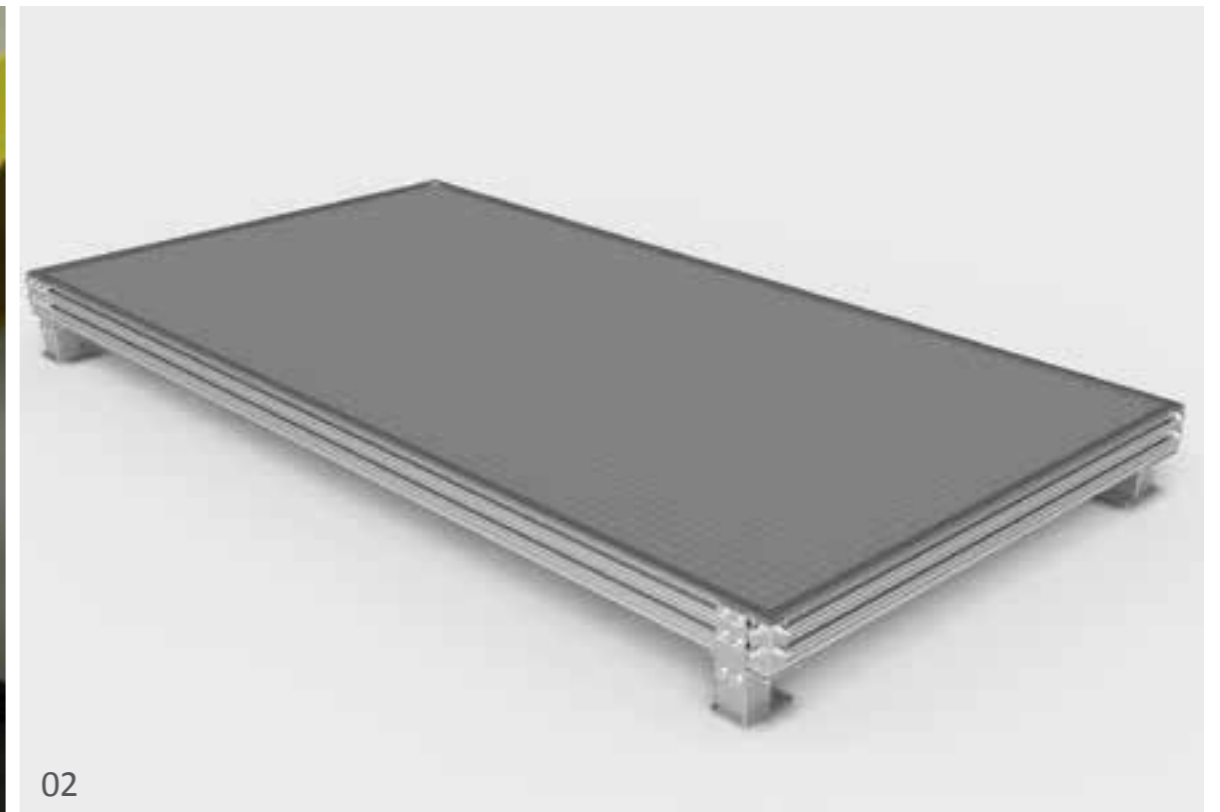



Modular aluminium working platform with internal access ladders designed to special applications

- 01 Project development
- 02 Project development
- 03 Project development
- 04 Project realization
- 05 Project realization



03



01



02



**Modular aluminium structure with internal access ladders and cantilever working platforms**  
designed for restoration of Florentine frescoes in Pisa

- 01 Project development
- 02 Structure detail
- 03 Project development
- 04 Project detail
- 05 Project realization



03



01



02



Modular aluminium access tower with connection platform designed for special applications

- 01 Project development
- 02 Project development
- 03 Project development
- 04 Project development

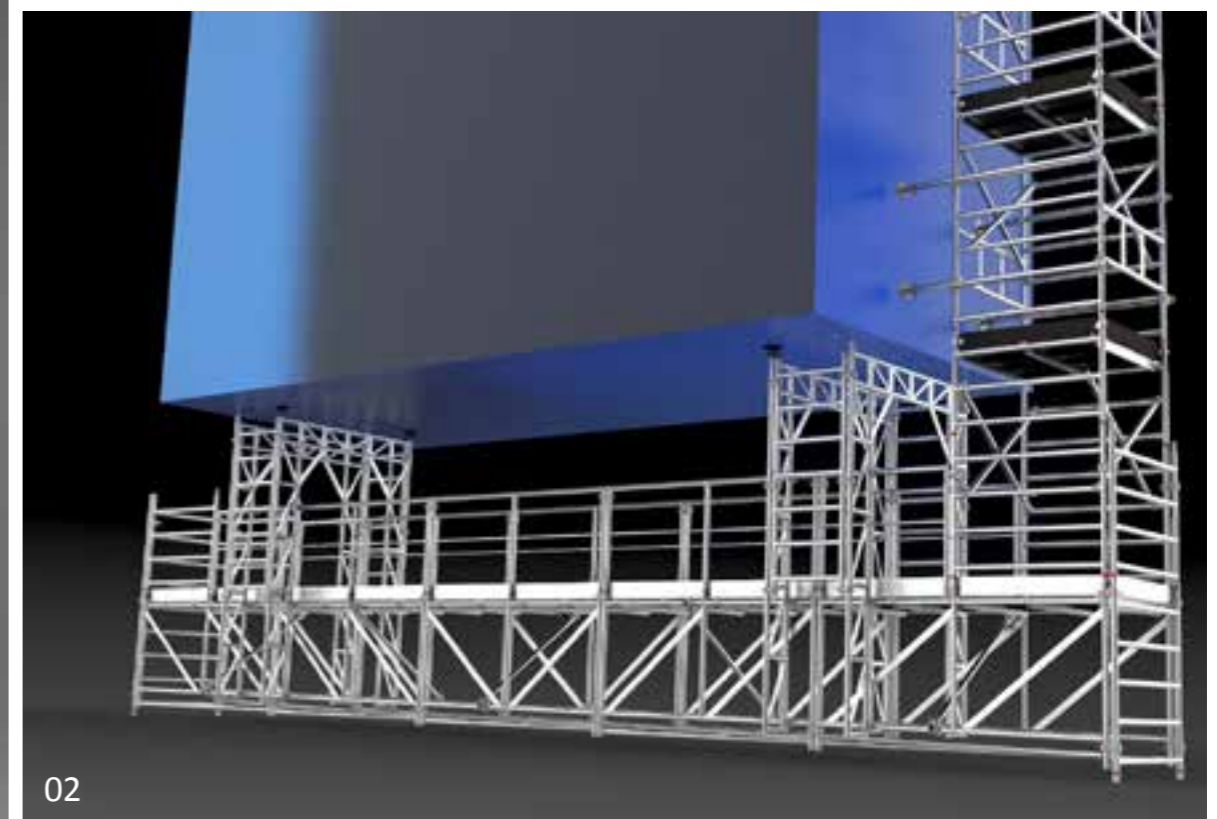
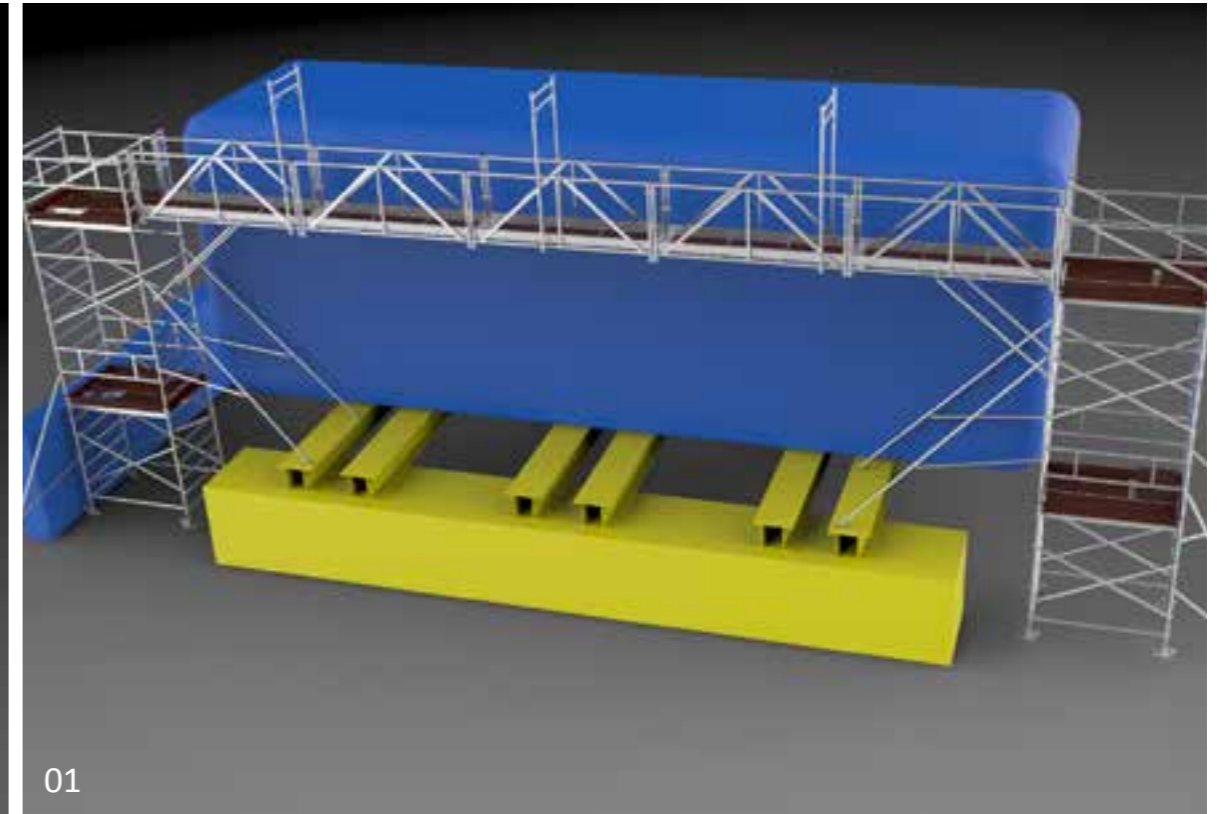
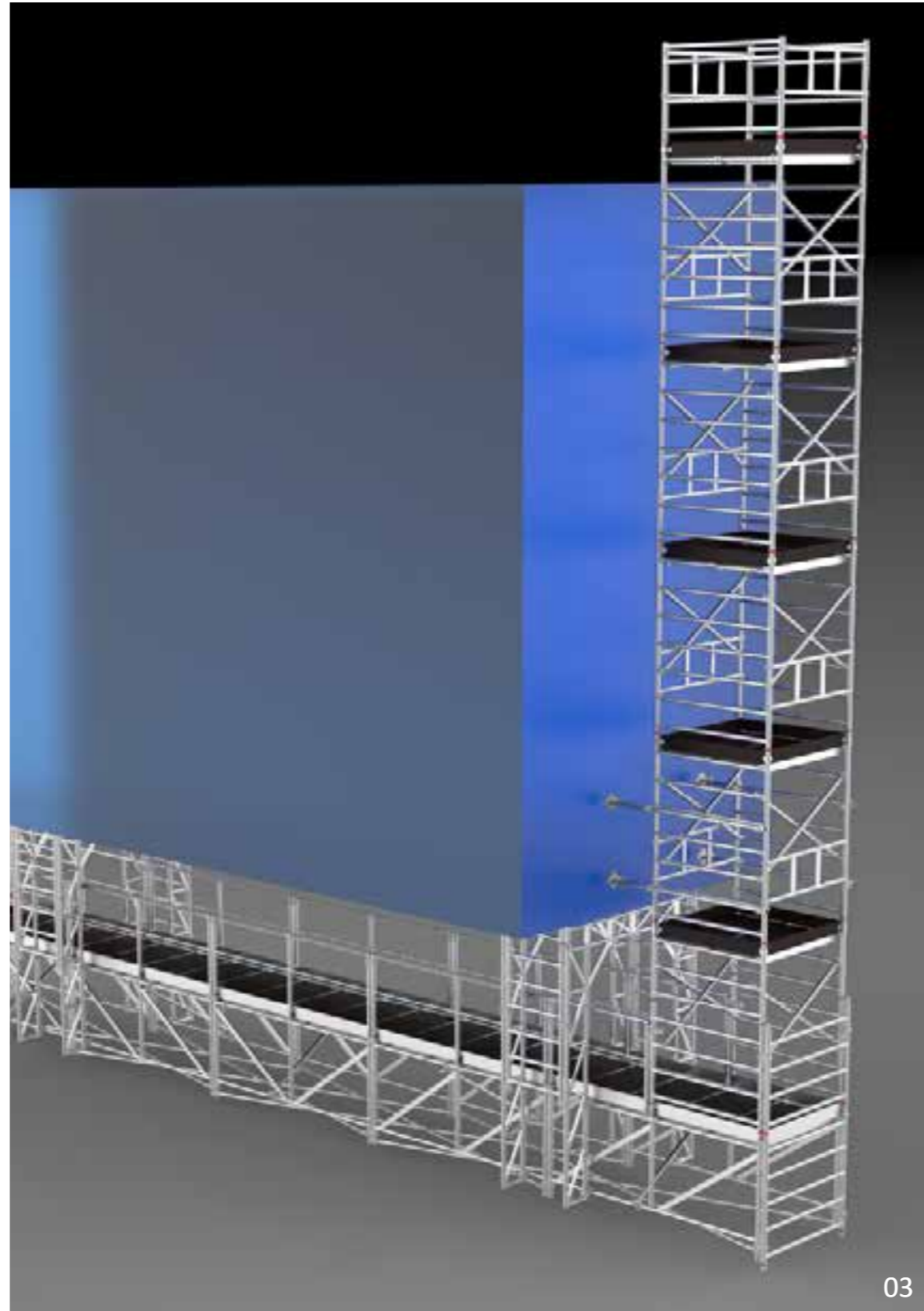



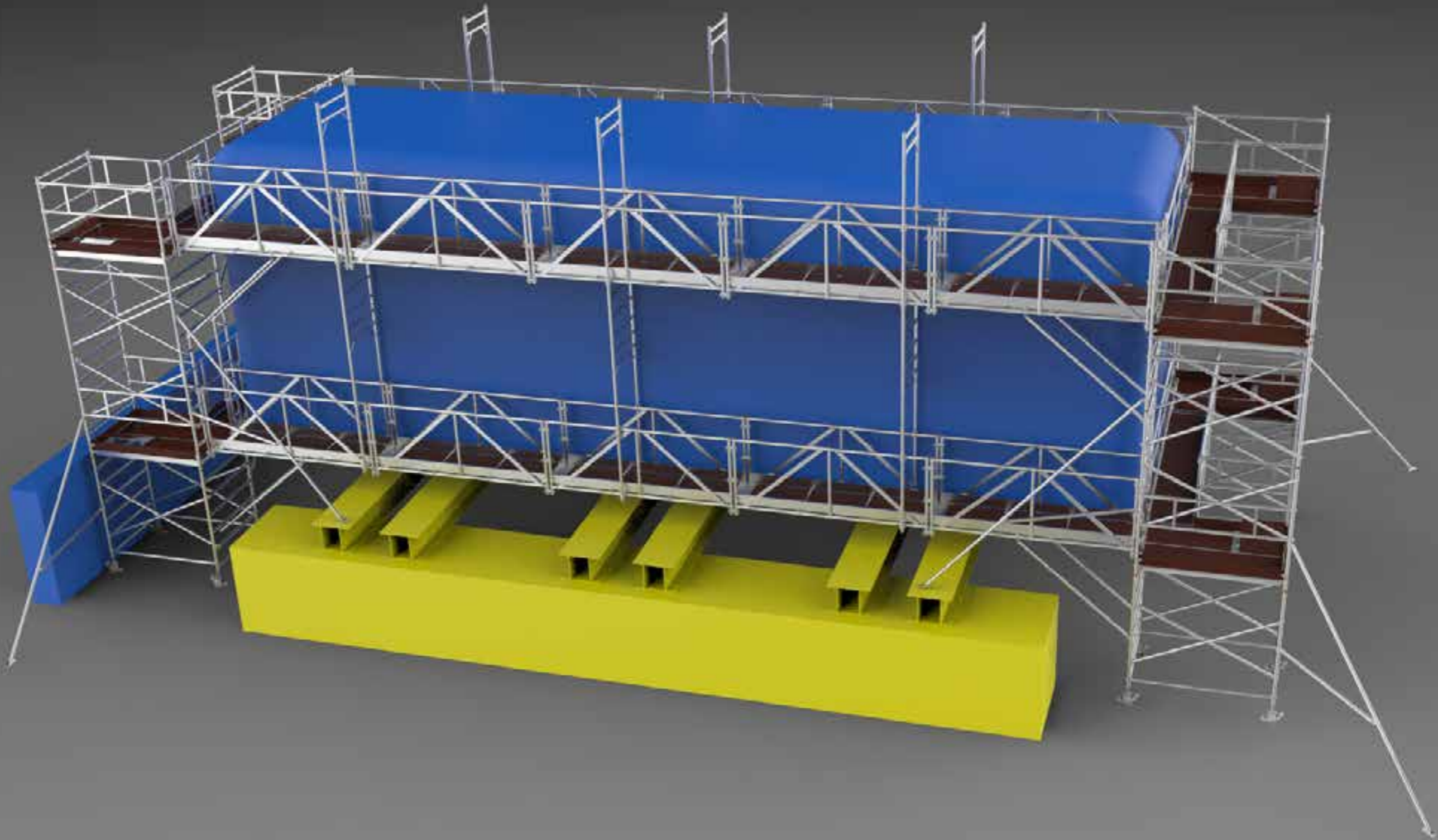





# Contact us

Frigerio Carpenterie S.p.A.

[www.frigeriospa.com](http://www.frigeriospa.com)

E-mail: [info@frigeriospa.com](mailto:info@frigeriospa.com)

24050 Orio al Serio (BG) Italy  
Via E. Fermi, 6

Tel. +39 035.4242.311

Fax +39 035.525.147

